

HF12-850WP-X

FEATURES

- Advanced pure lead technology
- The battery is designed for high rate usage
- Excellent consistency and reliability
- Longer float life
- Special design to avoid thermal runaway
- 4-fold terminal sealing to avoid leaking
- Strongest High Rated Discharge Performance
- Maintenance-free operation
- Low self-discharge rate

APPLICATION

- UPS Equipment (High rate)
- High power backup supply
- Emergency power supply
- Starting system
- Power tools
- Emergency lighting
- Electrical starting

SPECIFICATIONS

Nominal Voltage	12 V
Number of cell	6
Nominal Capacity	850W/cell @15 min rate F.V.(1.67V/cell)
Approx. Weight	67.5Kg(148.8 lbs) (Weight deviation: ± 3%)
Internal Resistance	≤ 2.5m Ω (Fully Charged,25°C)
Max. Discharge Current	1000 A (5 sec.)
Max. Charge Current	60 A
Operating Temperature Range	Charge : -10 °C~60 °C Discharge : -20 °C~60 °C Storage : -10 °C~60 °C
Nominal Operating Temperature Range	25 ±5°C
Container Material	ABS(UL94-HB)&Flammability resistance of(UL94-V0) can be available upon request.
Self Discharge	3% of capacity declined per month at 20 °C (average)
Charge Methods: Constant Voltage Charge (25 °C)	
Cycle use	2.40-2.45VPC
Temperature compensation	-30mV/°C
Standby use	2.20-2.30VPC
Temperature compensation	-20mV/°C

Dimensions

	SI Units	English Units
Length	526mm	20.7 inch
Width	238mm	9.37 inch
Height	246mm	9.69 inch
Total Height	246mm	9.69 inch

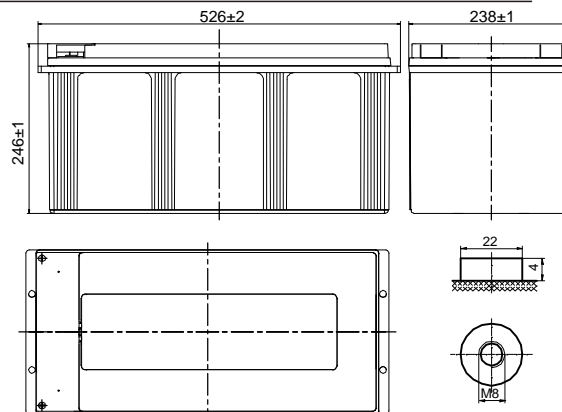

Constant Current Discharge (Amperes at 25 °C)

End Point Volts/cell	5 min	10min	15m in	20 min	30 min
1.60	780	603	468	370	289
1.67	727	570	440	354	277
1.70	692	536	415	338	266
1.75	652	505	395	321	254
1.80	607	485	381	305	242

Constant Power Discharge(Watts per Cell at 25 °C)

End Point Volts/cell	5 min	10min	15m in	20 min	30 min
1.60	1360	1096	880	667	509
1.67	1300	1056	850	642	494
1.70	1249	1013	816	624	480
1.75	1194	966	767	600	465
1.80	1131	922	744	582	450

(Note)The above characteristics data are average values obtained within three charge/discharge cycles not the minimum values.
All data shall be changed without prior notice, VISION reserves the right to explain and update the information contained hereinto.

HF12-850WP-X

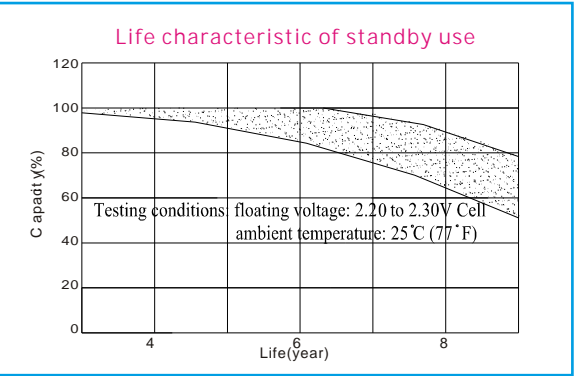
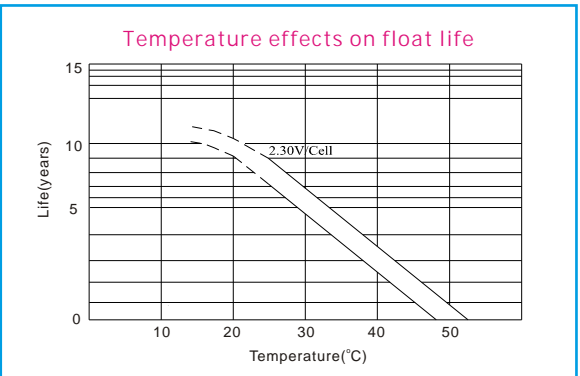
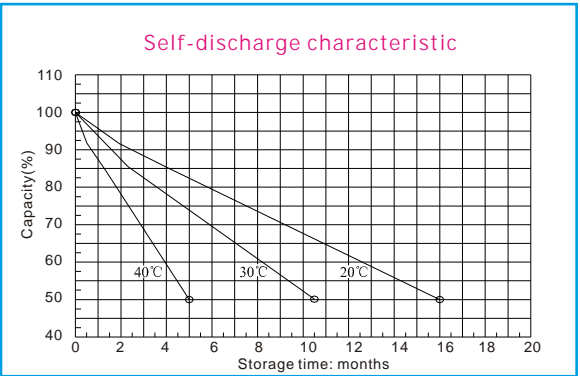
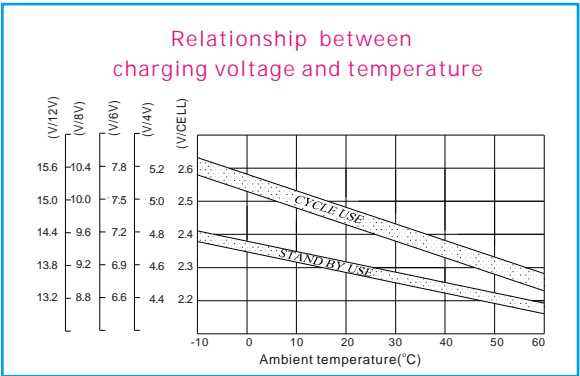
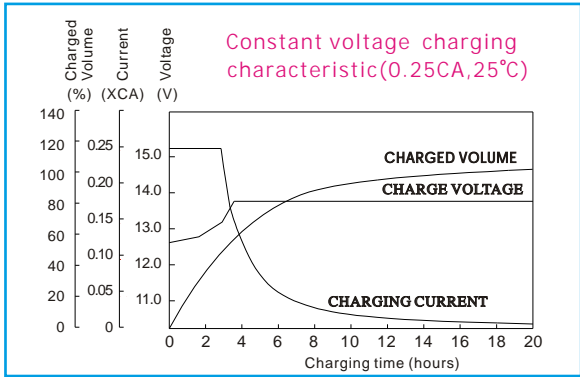
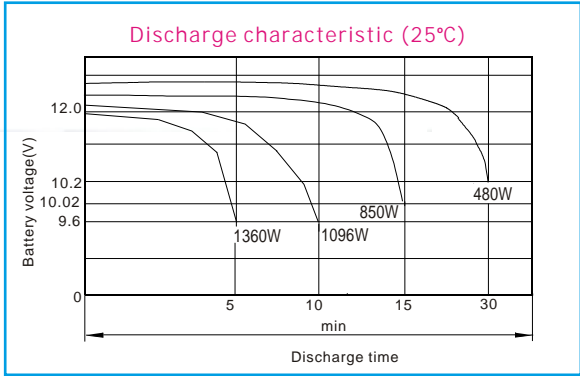



ISO9001:2008



MH25860



G4M19906-9202-E-16



www.vision-batt.com

Shenzhen Center Power Tech. Co., Ltd.
 Center Power Industrial Park, Tongfu Industrial District Dapeng Town, 518120 Shenzhen, China
 Tel: (+86-755) 8431 8088 Fax: (+86-755) 8431 8038 E-mail: sales@vision-batt.com