

HF12-420WP-X

FEATURES

- Advanced pure lead technology
- The battery is designed for high rate usage
- Excellent consistency and reliability
- Longer float life
- Special design to avoid thermal runaway
- 4-fold terminal sealing to avoid leaking
- Strongest High Rated Discharge Performance
- Maintenance-free operation
- Low self-discharge rate

APPLICATION

- UPS Equipment (High rate)
- High power backup supply
- Emergency power supply
- Starting system
- Power tools
- Emergency lighting
- Electrical starting

SPECIFICATIONS

Nominal Voltage	12 V
Number of cell	6
Nominal Capacity	420W/cell @15 min rate F.V.(1.67V/cell)
Approx. Weight	31.5Kg(69.4 lbs) (Weight deviation: ± 3%)
Internal Resistance	≤ 3.5m Ω (Fully Charged,25°C)
Max. Discharge Current	900 A (5 sec.)
Max. Charge Current	30 A
Operating Temperature Range	Charge : -10 °C~60°C Discharge : -20°C~60°C Storage : -10°C~60°C
Nominal Operating Temperature Range	25 ±5°C
Container Material	ABS(UL94-HB)&Flammability resistance of(UL94-V0) can be available upon request.
Self Discharge	3% of capacity declined per month at 20°C (average)
Charge Methods: Constant Voltage Charge (25°C)	
Cycle use	2.40-2.45VPC
Temperature compensation	-30mV/°C
Standby use	2.20-2.30VPC
Temperature compensation	-20mV/°C



Dimensions

	SI Units	English Units
Length	341mm	13.4 inch
Width	173mm	6.81 inch
Height	215mm	8.46 inch
Total Height	220mm	8.66 inch

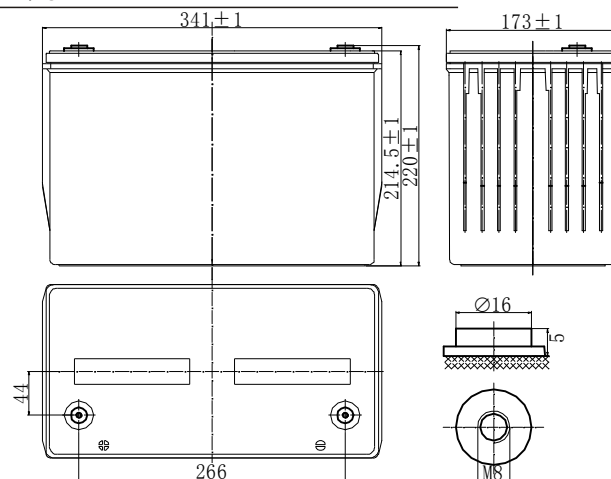

Constant Current Discharge (Amperes at 25°C)

End Point Volts/cell	3 m in	5 m in	10min	15 m in	20 min	30 min
1.60	634	460	317	240	190	160
1.67	608	434	295	225	178	152
1.70	571	411	280	210	167	140
1.75	545	390	267	200	162	135
1.80	509	365	250	191	156	127

Constant Power Discharge (Watts per Cell at 25°C)

End Point Volts/cell	3 min	5 min	10min	15 m in	20 min	30 min
1.60	1029	800	568	437	348	292
1.67	968	751	538	420	335	285
1.70	924	711	508	395	323	272
1.75	873	667	477	372	303	260
1.80	823	627	454	349	290	251

(Note)The above characteristics data are average values obtained within three charge/discharge cycles not the minimum values.
All data shall be changed without prior notice, VISION reserves the right to explain and update the information contained hereinto.

HF12-420WP-X

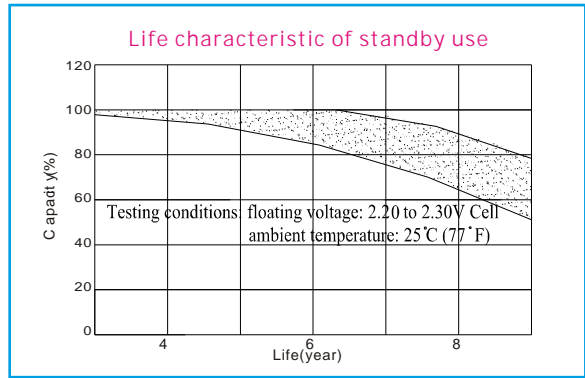
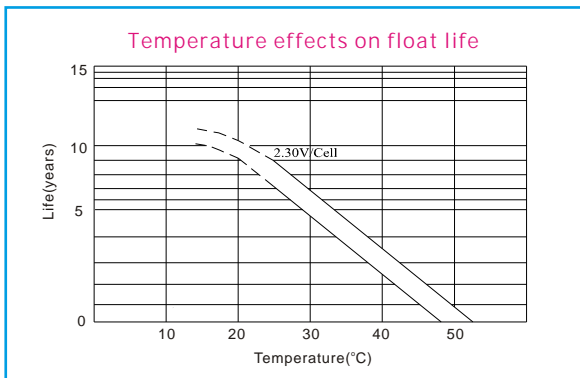
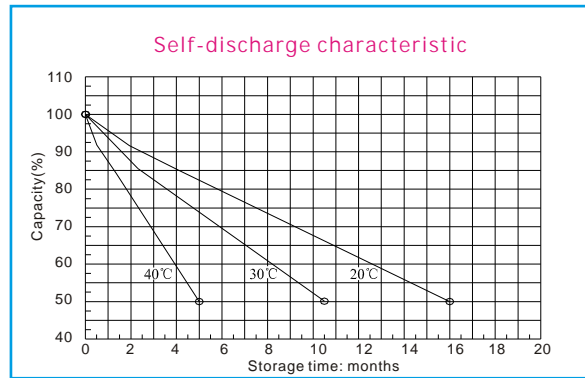
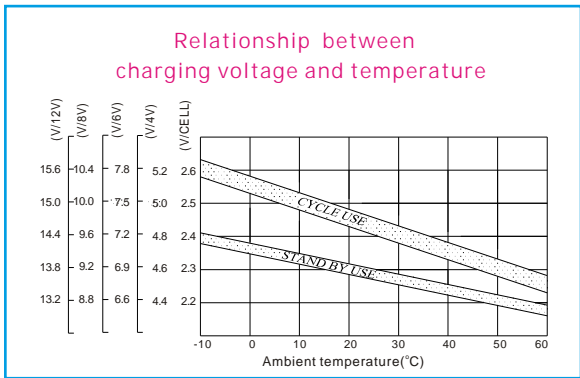
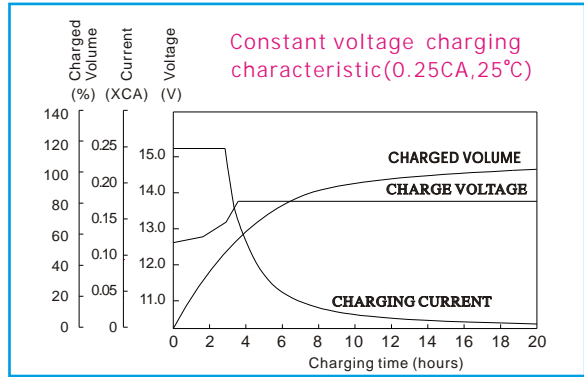
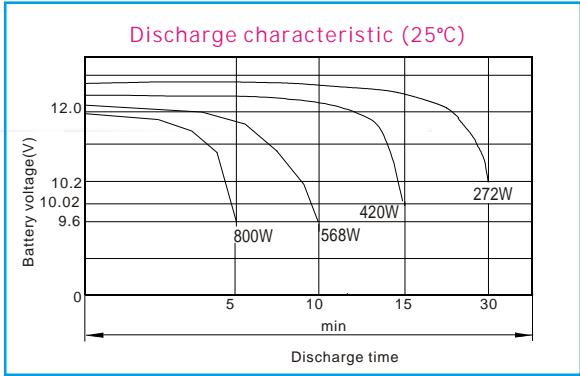



ISO9001:2008



MH25860





www.vision-batt.com

Shenzhen Center Power Tech. Co., Ltd.
 Center Power Industrial Park, Tongfu Industrial District Dapeng Town, 518120 Shenzhen, China
 Tel: (+86-755) 8431 8088 Fax: (+86-755) 8431 8038 E-mail: sales@vision-batt.com