

# CP1270A 12V7Ah

The rechargeable batteries are lead-lead dioxide systems. The dilute sulfuric acid electrolyte is absorbed by separators and plates and thus immobilized. Should the battery be accidentally overcharged producing hydrogen and oxygen, special one-way valves allow the gases to escape thus avoiding excessive pressure build-up. Otherwise, the battery is completely sealed and is, therefore, maintenance-free, leak proof and usable in any position.



## Construction

Component	Positive plate	Negative plate	Container	Cover	Safety valve	Terminal	Separator	Electrolyte
Raw material	Lead dioxide	Lead	ABS	ABS	Rubber	Copper	Fiberglass	Sulfuric acid

## General Features

- Absorbent Glass Mat (AGM) technology for efficient gas recombination of up to 99% and freedom from electrolyte maintenance or water adding.
- Not restricted for air transport-complies with IATA/ICAO Special Provision A67.
- UL-recognized component.
- Can be mounted in any orientation.
- Computer designed lead, calcium tin alloy grid for high power density.
- Long service life, float or cyclic applications.
- Maintenance-free operation.
- Low self discharge.
- Case and cover available in both standard and flame retardant ABS.

## Dimensions and Weight

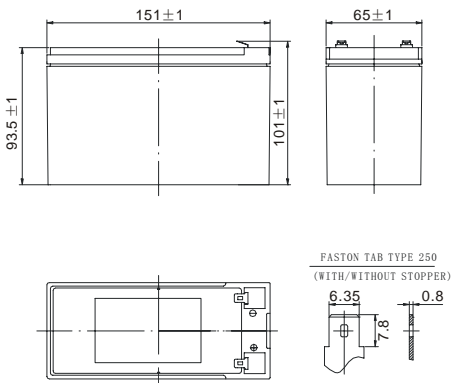

## Technology Parameter

Battery model	CP1270A			
nominal voltage	12V			
Number of cell	6			
Capacity (25°C)	20hR (0.35A, 10.5V)	10hR (0.682A, 10.5V)	5hR (1.18A, 10.5V)	1hR (4.68A, 9.6V)
	7.0Ah	6.82Ah	5.9Ah	4.68Ah
Dimensions	Length	Width	Height	Total Height
	151±1mm	65±1mm	93.5±1mm	101±1mm
Approx. weight	2.37Kg (5.22 lbs)			
Internal resistance	Full charged at 25°C: ≤ 25mOhms			
Self discharge	3% of capacity declined per month at 20°C (average)			
Operating temperature range	Discharge	Charge	Storage	
	-20~60°C	-10~60°C	-20~60°C	
Max. discharge current (25°C)	140A (5s)			
Short circuit current	450A			

## Discharge ratings-amperes at 25°C(77°F)

End Point Volts/Cell	5min	10min	15min	30min	1h	3h	5h	10h	20h
1.60V	31.7	20.0	14.9	8.76	4.68	2.00	1.33	0.718	0.363
1.65V	29.8	19.7	14.5	8.68	4.57	1.93	1.28	0.706	0.359
1.70V	28.1	19.4	14.1	8.61	4.46	1.87	1.23	0.691	0.355
1.75V	26.3	18.8	13.7	8.53	4.35	1.77	1.18	0.682	0.350
1.80V	24.1	17.8	13.1	8.33	4.21	1.65	1.12	0.664	0.344

## Discharge ratings-watts per cell at 25°C(77°F)

End Point Volts/Cell	5min	10min	15min	30min	45min	1h	2h	3h	5h
1.60V	58.6	38.2	27.8	16.8	12.1	9.20	5.28	3.97	2.55
1.65V	55.6	37.6	27.2	16.6	11.7	8.98	5.13	3.84	2.47
1.70V	52.6	37.0	26.5	16.3	11.6	8.77	4.98	3.72	2.39
1.75V	49.4	36.5	25.9	16.0	11.3	8.55	4.78	3.53	2.30
1.80V	45.4	34.8	25.2	15.7	11.0	8.27	4.54	3.29	2.19

(Note)The above characteristics data are average values obtained within three charge/discharge cycles not the minimum values.  
All data shall be changed without notice, Vision reserves the right to explain and update the information contained hereinto.



# VISION

# CP1270A<sub>12V7Ah</sub>

Vision Rechargeable Products

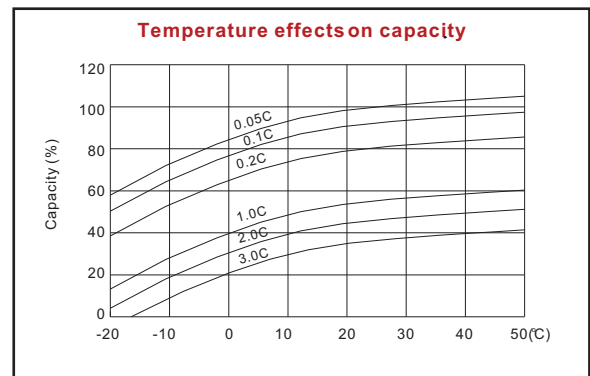
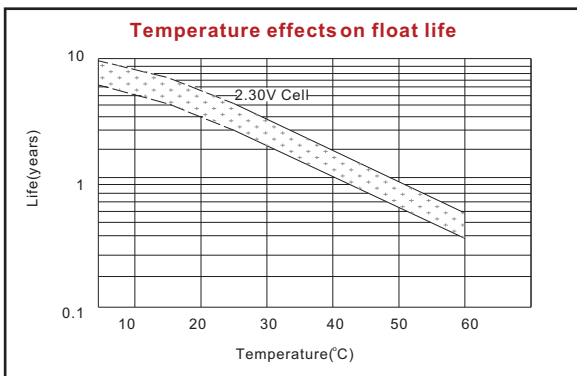
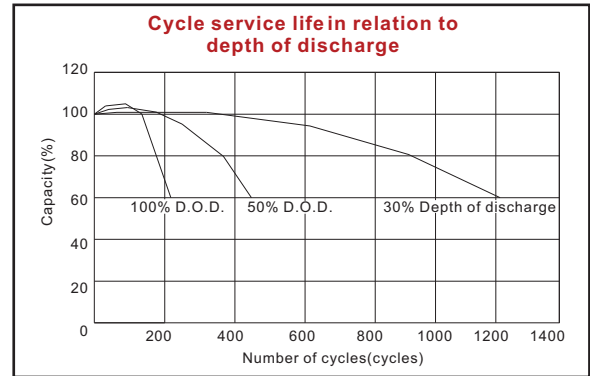
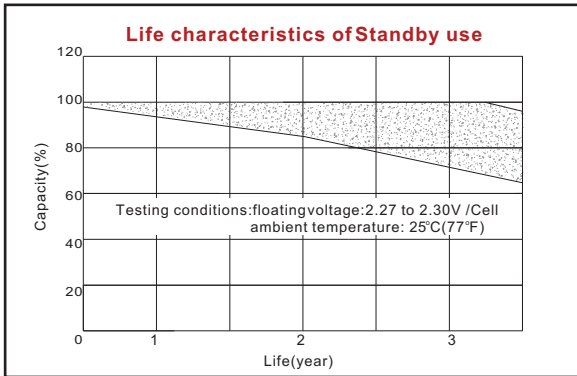
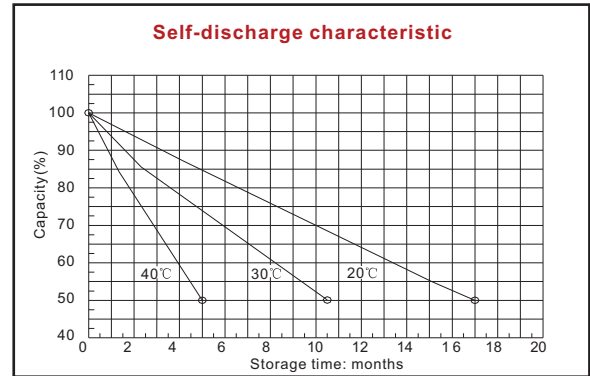
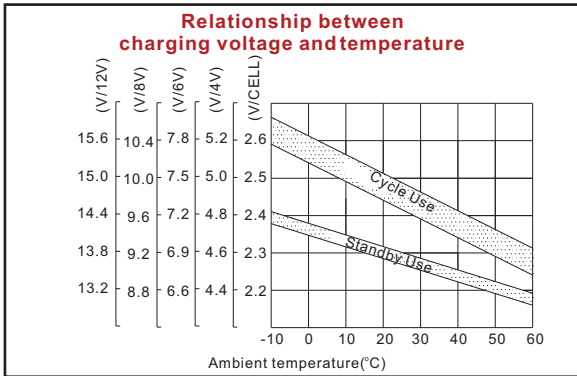
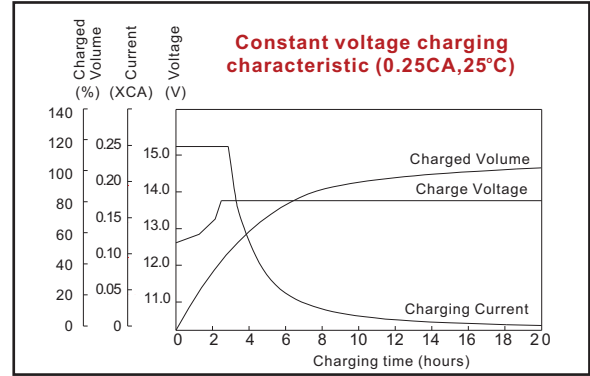
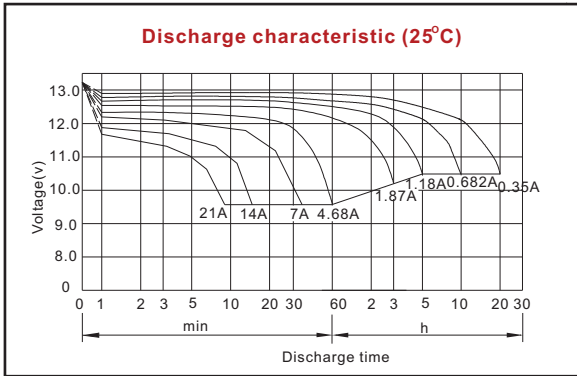

**Shenzhen Center Power Tech. Co., Ltd.**  
 Center Power Industrial Park, Tongfu Industrial District Dapeng Town,  
 518120 Shenzhen, China  
 Tel: +86-755-8431 8088 Fax: +86-755-8431 8038  
 Email: sales@vision-batt.com

