

## CP1223 12V 2.3Ah(20hr)

The rechargeable batteries are lead-lead dioxide systems. The dilute sulfuric acid electrolyte is absorbed by separators and plates and thus immobilized. Should the battery be accidentally overcharged producing hydrogen and oxygen, special one-way valves allow the gases to escape thus avoiding excessive pressure build-up. Otherwise, the battery is completely sealed and is, therefore, maintenance-free, leak proof and usable in any position.



### Battery Construction

Component	Positive plate	Negative plate	Container	Cover	Safety valve	Terminal	Separator	Electrolyte
Raw material	Lead dioxide	Lead	ABS	ABS	Rubber	Copper	Fiberglass	Sulfuric acid

### General Features

- Absorbent Glass Mat (AGM) technology for efficient gas recombination of up to 99% and freedom from electrolyte maintenance or water adding.
- Not restricted for air transport-complies with IATA/ICAO Special Provision A67.
- UL-recognized component.
- Can be mounted in any orientation.
- Computer designed lead, calcium tin alloy grid for high power density.
- Long service life, float or cyclic applications.
- Maintenance-free operation.
- Low self discharge.

### Dimensions and Weight

Length(mm / inch)	178 / 7.01
Width(mm / inch)	35 / 1.38
Height(mm / inch)	61 / 2.40
Total Height(mm / inch)	67 / 2.64
Approx. Weight(Kg / lbs)	0.99 / 2.18

\* Weight deviation:  $\pm 5\%$

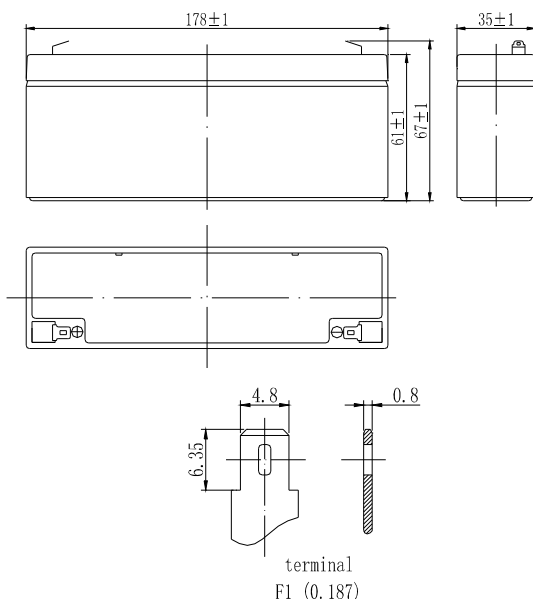

### Performance Characteristics

Nominal Voltage	12V
Number of cell	6
Design Life	5 years
Nominal Capacity 77°F(25°C)	
20 hour rate (0.115A, 10.5V)	2.3Ah
10 hour rate (0.2A, 10.5V)	2Ah
5 hour rate (0.37A, 10.5V)	1.85Ah
1 hour rate (1.46A, 9.6V)	1.46Ah
Internal Resistance	
Fully Charged battery 77°F(25°C)	$\leq 60\text{mOhms}$
Self-Discharge	
3% of capacity declined per month at 20°C(average)	
Operating Temperature Range	
Discharge	-20~60°C
Charge	-10~60°C
Storage	-20~60°C
Max. Discharge Current 77°F(25°C)	34.5A(5s)
Short Circuit Current	115A
Charge Methods: Constant Voltage Charge 77°F(25°C)	
Cycle use	2.40-2.45VPC
Maximum charging current	0.92A
Temperature compensation	-30mV/°C
Standby use	2.23-2.30VPC
Temperature compensation	-20mV/°C

### Discharge Constant Current (Amperes at 77°F25°C)

End Point Volts/Cell	5min	10min	15min	30min	1h	3h	5h	10h	20h
1.60V	9.00	5.70	4.40	2.50	1.46	0.59	0.41	0.22	0.120
1.65V	8.64	5.47	4.27	2.41	1.38	0.57	0.40	0.22	0.120
1.70V	8.27	5.23	4.13	2.29	1.29	0.54	0.39	0.21	0.120
1.75V	7.89	4.98	3.98	2.16	1.19	0.49	0.37	0.20	0.115
1.80V	7.50	4.72	3.82	2.02	1.08	0.45	0.34	0.18	0.103

### Discharge Constant Power (Watts at 77°F25°C)

End Point Volts/Cell	5min	10min	15min	30min	45min	1h	2h	3h	5h
1.60V	17.5	11.00	8.50	4.83	3.50	2.78	1.54	1.08	0.75
1.65V	16.7	10.50	8.14	4.52	3.38	2.46	1.45	1.04	0.74
1.70V	16.0	10.00	7.86	4.28	3.25	2.28	1.35	0.98	0.73
1.75V	15.3	9.46	7.56	4.02	3.11	2.09	1.14	0.93	0.71
1.80V	14.4	8.94	7.24	3.74	3.00	1.86	1.02	0.84	0.62

(Note)The above characteristics data are average values obtained within three charge/discharge cycles not the minimum values.  
All data shall be changed without notice,Vision reserves the right to explain and update the information contained hereinto.

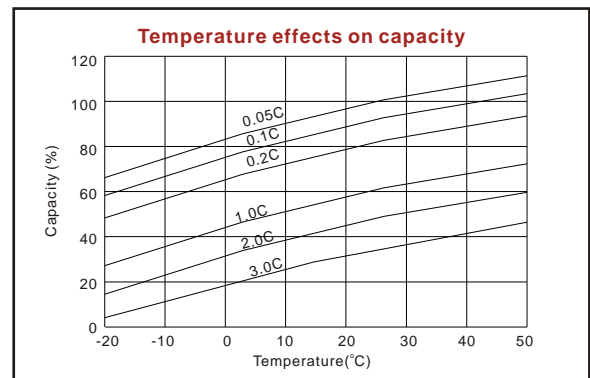
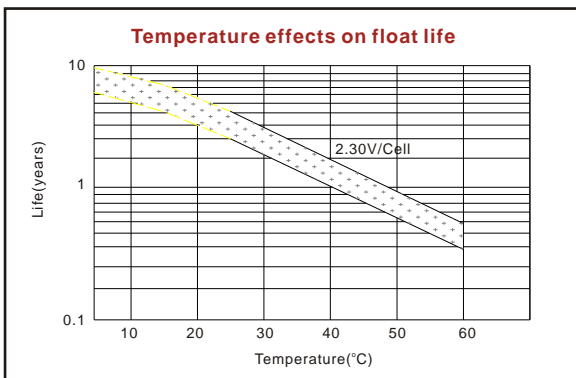
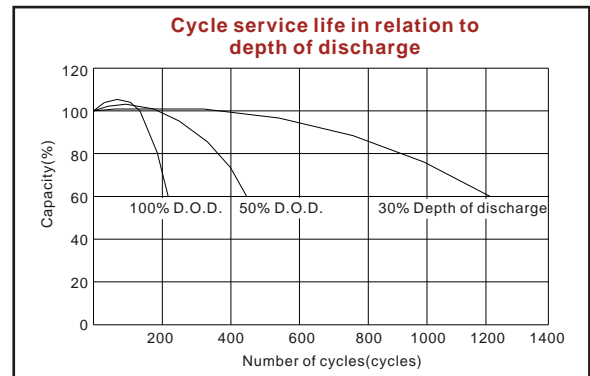
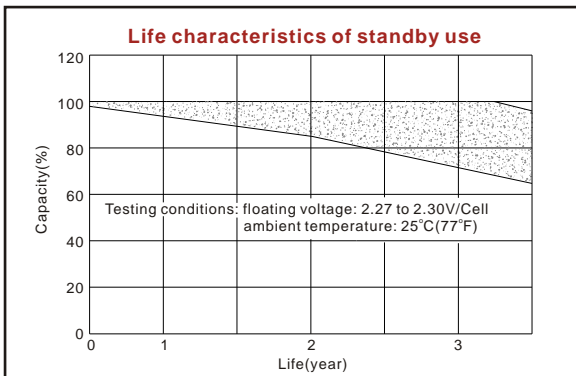
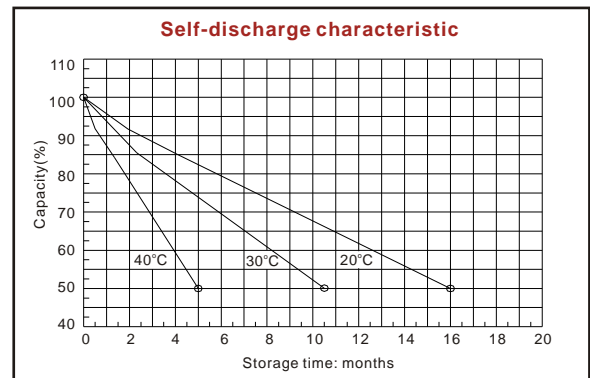
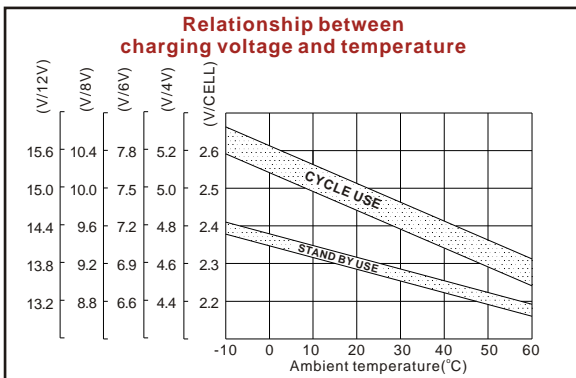
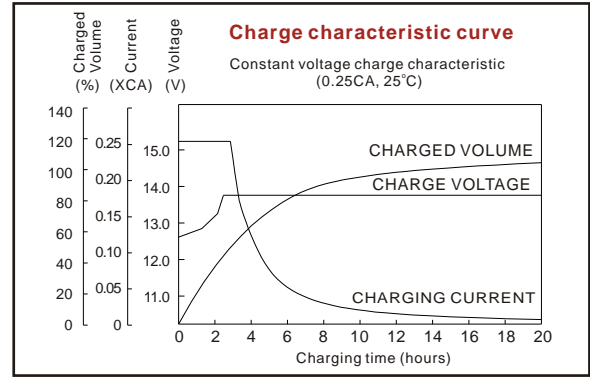
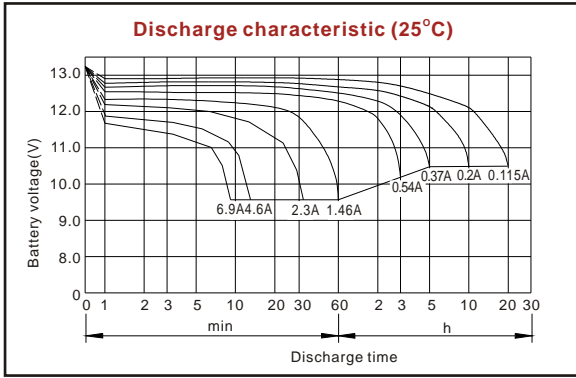

ISO9001:2008

MH25860

G4M19906-9202-E-16

[www.vision-batt.com](http://www.vision-batt.com)

**Shenzhen Center Power Tech. Co., Ltd.**  
 Center Power Industrial Park, Tongfu Industrial District Dapeng Town, 518120 Shenzhen, China  
 Tel: (+86-755) 8431 8088 Fax: (+86-755) 8431 8038 E-mail: sales@vision-batt.com