

6FM150D-X 12V 150Ah(20hr)

The rechargeable batteries are lead-lead dioxide systems. The dilute sulfuric acid electrolyte is absorbed by separators and plates and thus immobilized. Should the battery be accidentally overcharged producing hydrogen and oxygen, special one-way valves allow the gases to escape thus avoiding excessive pressure build-up. Otherwise, the battery is completely sealed and is, therefore, maintenance-free, leak proof and usable in any position.



Battery Construction

Component	Positive plate	Negative plate	Container	Cover	Safety valve	Terminal	Separator	Electrolyte
Raw material	Lead dioxide	Lead	ABS	ABS	Rubber	Copper	Fiberglass	Sulfuric acid

General Features

- Absorbent Glass Mat (AGM) technology for efficient gas recombination of up to 99% and freedom from electrolyte maintenance or water adding.
- Not restricted for air transport-complies with IATA/ICAO Special Provision A67.
- UL-recognized component.
- Can be mounted in any orientation.
- Computer designed lead, calcium tin alloy grid for high power density.
- Long service life, float or cyclic applications.
- Maintenance-free operation.
- Low self discharge.

Dimensions and Weight

Length(mm / inch)	482 / 19.0
Width(mm / inch)	170 / 6.69
Height(mm / inch)	240 / 9.45
Total Height(mm / inch)	240 / 9.45
Approx. Weight(Kg / lbs)	48.4 / 106.7

* Weight deviation: $\pm 3\%$

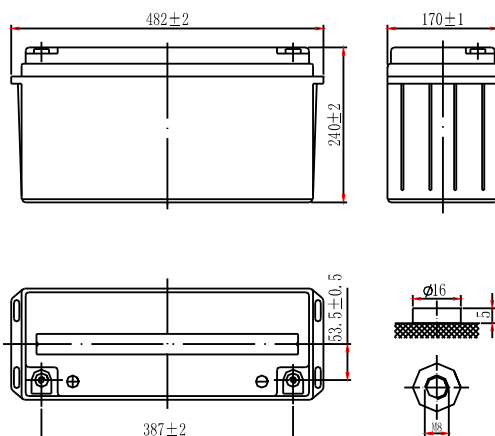

Performance Characteristics

Nominal Voltage	12V
Number of cell	6
Design Life	10 years
Nominal Capacity 77°F(25°C)	
20 hour rate (7.50A, 10.8V)	150Ah
10 hour rate (14.3A, 10.8V)	143Ah
5 hour rate (26.9A, 10.5V)	134.5Ah
1 hour rate (100A, 9.6V)	100Ah
Internal Resistance	
Fully Charged battery 77°F(25°C)	$\leq 4.5\text{mOhms}$
Self-Discharge	
3% of capacity declined per month at 20°C(average)	
Operating Temperature Range	
Discharge	-20~60°C
Charge	-10~60°C
Storage	-20~60°C
Max. Discharge Current 77°F(25°C)	1000A(5s)
Short Circuit Current	2700A
Charge Methods: Constant Voltage Charge 77°F(25°C)	
Cycle use	2.40-2.45VPC
Maximum charging current	45A
Temperature compensation	-30mV/°C
Standby use	2.20-2.30VPC
Temperature compensation	-20mV/°C

Discharge Constant Current (Amperes at 77°F25°C)

End Point Volts/Cell	10min	15min	30min	45min	1h	3h	5h	10h	20h
1.60V	346	280	165	121	100	44.1	28.7	14.7	7.70
1.65V	314	259	158	118	97.5	43.8	28.1	14.6	7.65
1.70V	301	251	156	116	94.9	43.4	27.5	14.5	7.60
1.75V	277	233	152	112	92.0	43.0	26.9	14.4	7.55
1.80V	254	216	146	108	89.2	41.0	26.4	14.3	7.50

Discharge Constant Power (Watts at 77°F25°C)

End Point Volts/Cell	10min	15min	30min	45min	1h	2h	3h	5h
1.60V	613	526	325	238	189	110	83.7	55.1
1.65V	590	489	297	230	183	108	83.1	53.8
1.70V	544	455	293	225	178	107	82.5	52.9
1.75V	512	431	287	220	174	105	81.3	51.8
1.80V	479	413	282	217	172	103	80.0	50.7

(Note)The above characteristics data are average values obtained within three charge/discharge cycles not the minimum values.

All data shall be changed without notice, Vision reserves the right to explain and update the information contained hereinto.

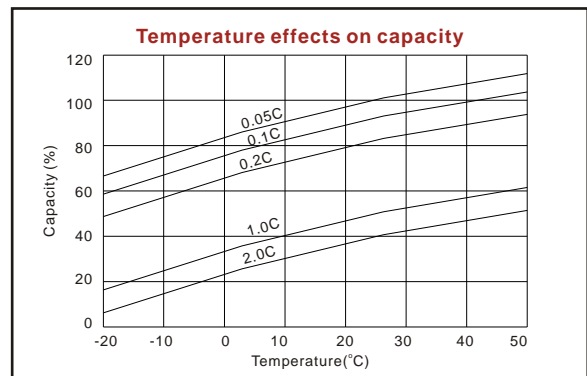
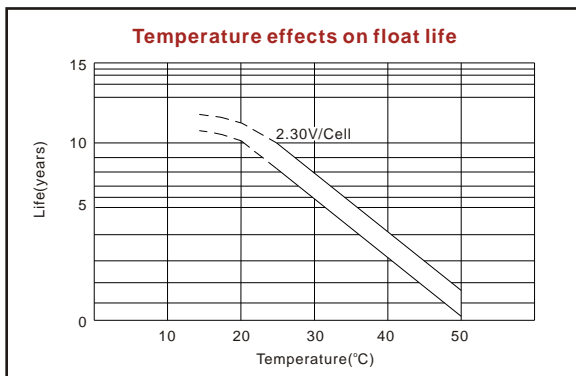
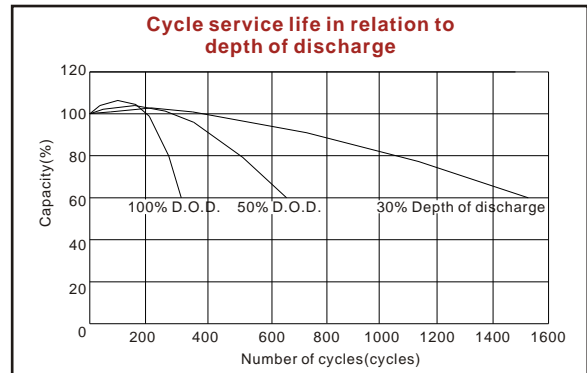
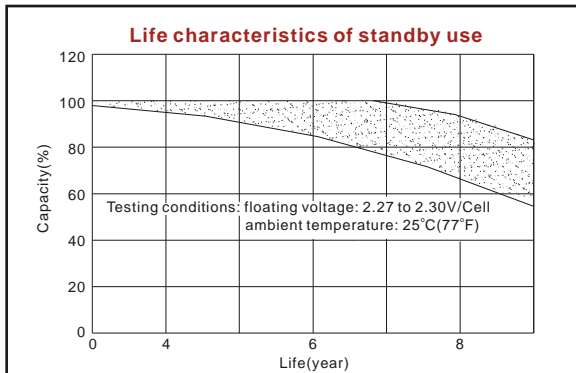
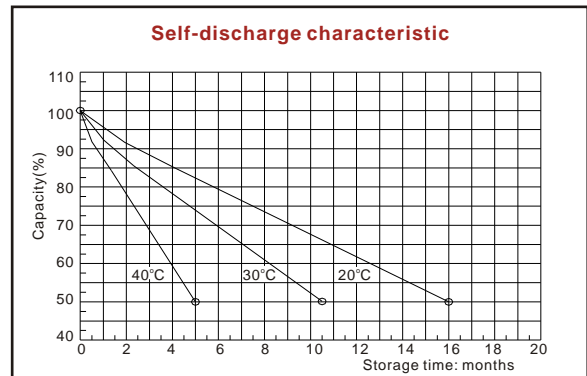
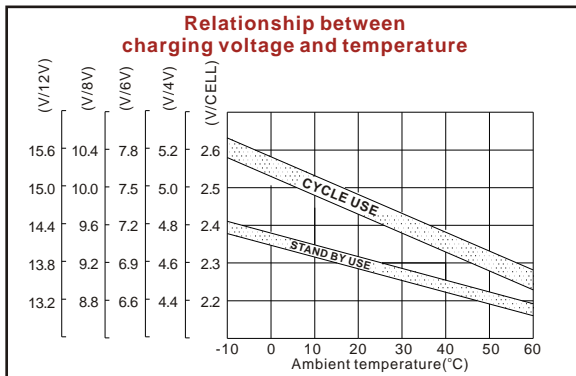
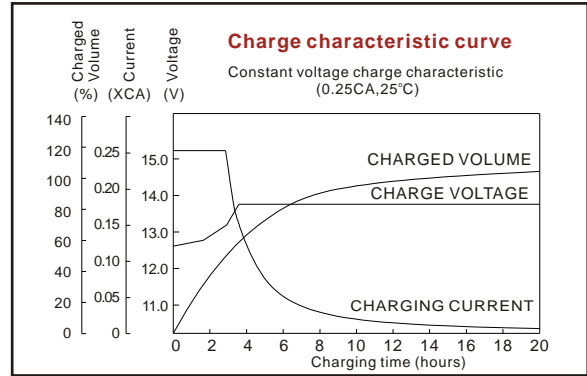
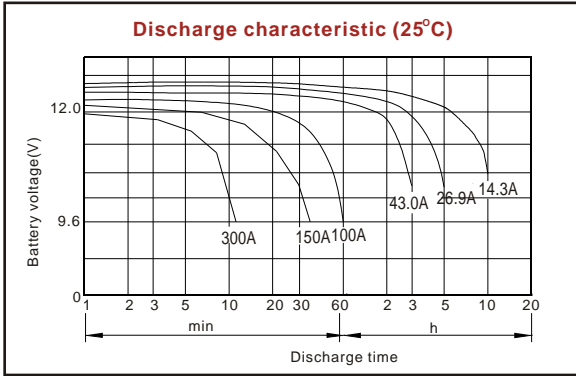

ISO9001:2008

MH25860

G4M19906-9202-E-16

www.vision-batt.com

Shenzhen Center Power Tech. Co., Ltd.
 Center Power Industrial Park, Tongfu Industrial District Dapeng Town, 518120 Shenzhen, China
 Tel: (+86-755) 8431 8088 Fax: (+86-755) 8431 8038 E-mail: sales@vision-batt.com